

Article number: 20192B45B45652BL

Description: E+G

T-angle clamps GN192-B45-B45-65-2-BL

Measures

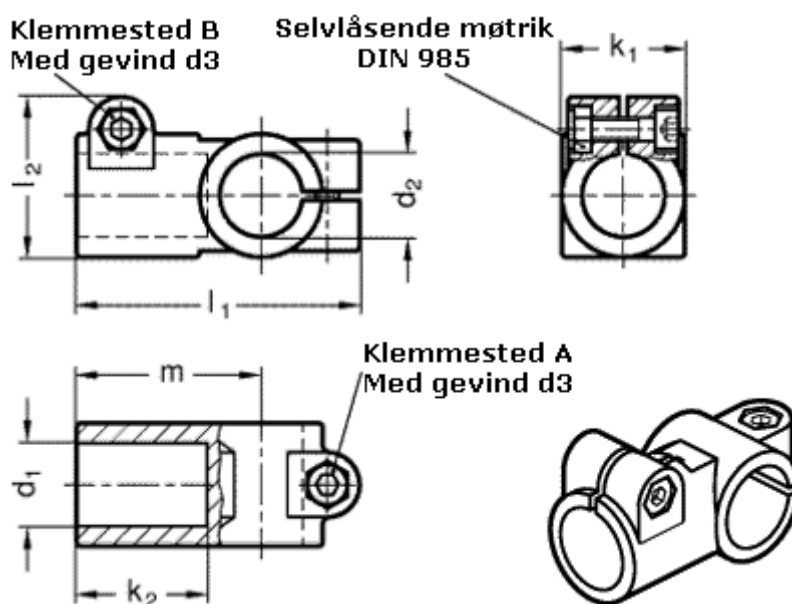

d1 = B45

d2 = B45

d3 = M10

k1 = 65

k2 = 75.0

l1 = 148

l2 = 77.5

m = 103